

pal 50

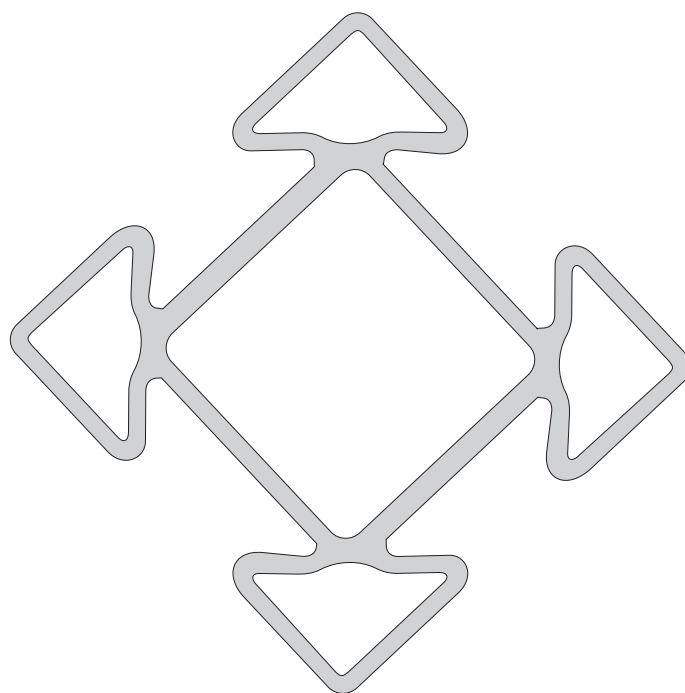

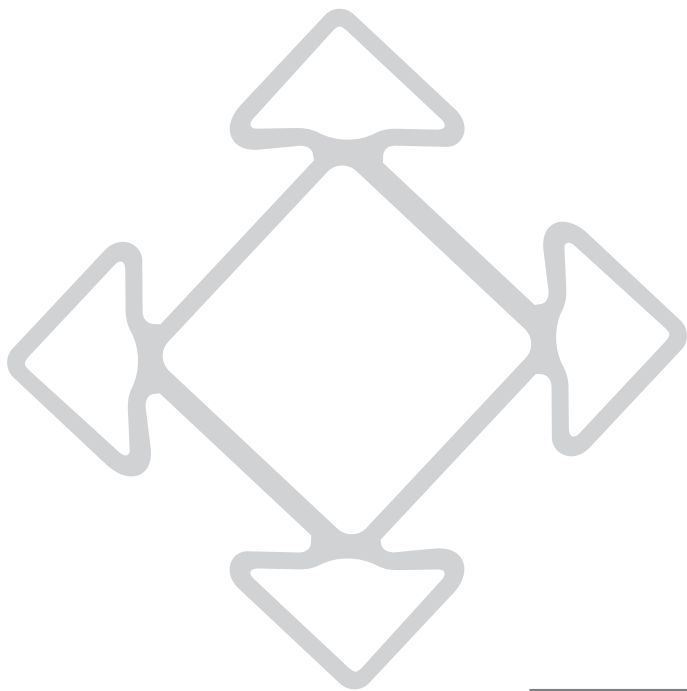

design by mwork



flexibilidad

flexibility



La tecnología aplicada al proyecto pal50 nos muestra una perspectiva diferente de amueblar y dividir los espacios de oficina. La flexibilidad y homogeneidad de sus elementos hacen de pal50 un sistema de alto diseño destinado a crear ambientes equilibrados y funcionales.

The technology applied in the pal50 project gives us a different perspective towards furnishing and division of office spaces. The flexibility and homogeneousness of its elements makes the pal50 a system of first class design destined to create stable and functional environments.



mobiliario furniture	04
box de reunión meeting cubicles	08
bench de trabajo work bench	16
mostradores reception desks	26
áreas de trabajo workstations	28
mamparas partitions	32

índice

index





mobiliario furniture





box de reunión
meeting cubicles

















ambientes equilibrados y luminosos bright and balanced atmospheres

bench de trabajo work bench





















mostradores de trabajo específicos
reception desks







áreas de trabajo
workstations







mamparas partitions









madera wood









espacios privados
private spaces







máxima flexibilidad maximum flexibility









perfilería y herrajes
profiles and ironworks





pal 50 mamparas | especificaciones técnicas technical specifications

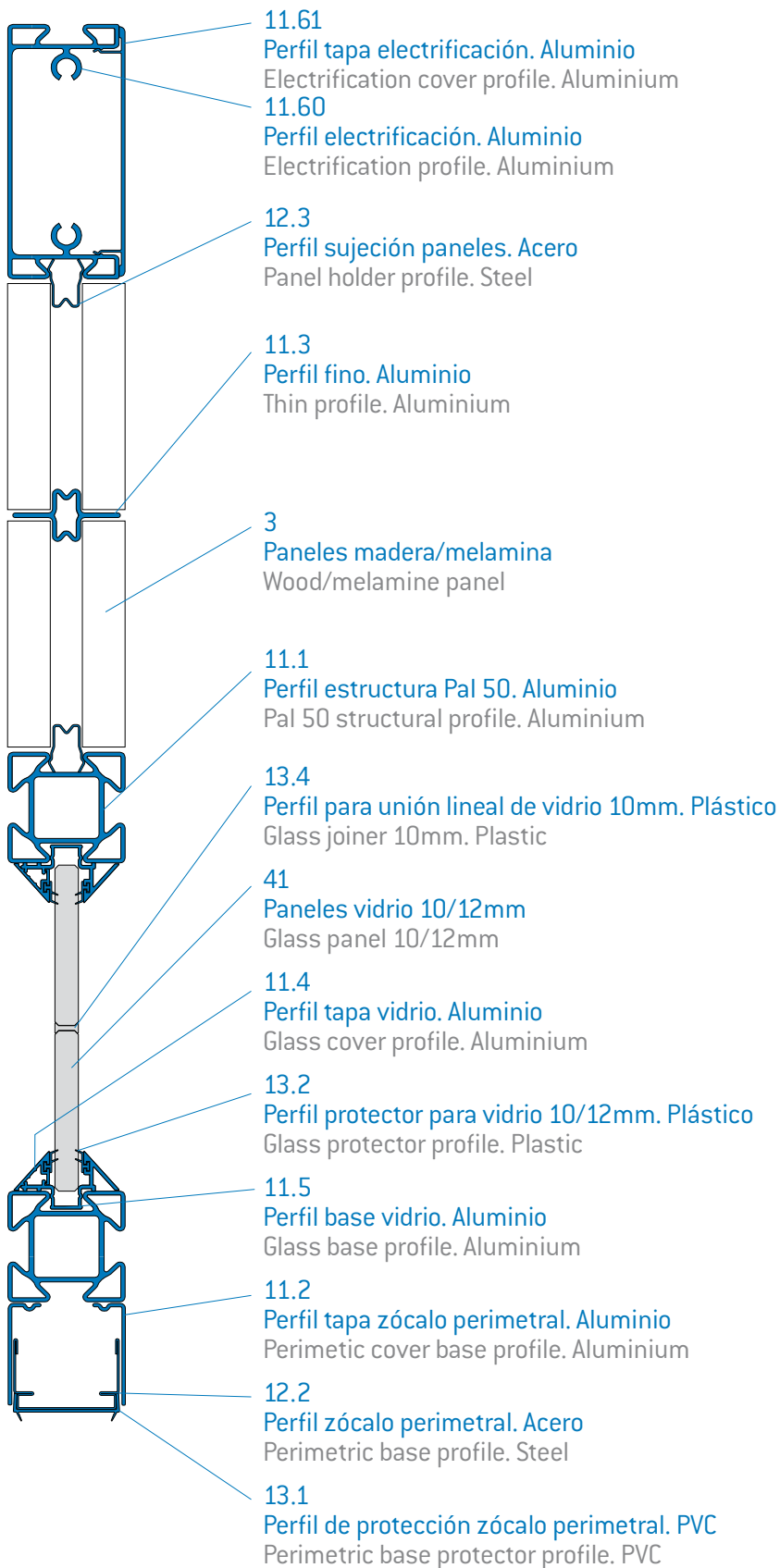

estructura structure	<p>Las paredes divisorias pal50 constan de una estructura perimetral de acero zincado con nervadura que soporta al resto de componentes de los módulos (paneles, vidrios y puertas). El resto de perfiles son de aluminio. El espesor de la estructura es de 50mm, la altura de los módulos depende de los requerimientos. Esta estructura ha sido diseñada para resolver efectivamente problemas de acople tanto a la pared como al techo, cruces multivías, variadas tipologías...</p> <p>internal dividing partitions pal50 consists of a perimetric zinc-plated structure with ribbing that is designed to support the different components of the module (panel, glass and doors). The rest of the profiles are made in aluminium. The minimum thickness of the structure is 50mm. The module´s height depends on the request. This structure has been designed to solve connecting problems in walls and ceilings, multi-way crosses, varied types...</p>
tratamientos treatments	<p>El tratamiento anticorrosivo del aluminio se realiza mediante anodizado ARS10 de color plata mate.</p> <p>Anticorrosive treatment of all aluminium parts through the ARS10 anodizing process of the satined silver colour.</p>
tolerancias tolerances	<p>El sistema constructivo de la pared pal 50 absorbe las variaciones de desniveles en suelos y paredes hasta +/- 6cm conservando un perfecto aspecto estético y sin piezas especiales.</p> <p>Pal 50 building system allows the absorption of the wall structures' size changes +/- 6cm keeping a perfect aesthetic appearance and without using any special pieces.</p>
paneles panels	<p>Los paneles tanto de madera como de melamina tienen un grosor estándar de 18mm, un núcleo central de material fibroso y formaldehído + 2 planchas de melamina/chapa...</p> <p>The wood panels as much as of melamine panels have a standard thickness of 18mm, a central nucleus of fibrous material and formaldehyde + 2 melamine boards...</p>
vidrio glass	<p>Los paneles de vidrio pueden ir de 5 a 12mm de espesor según necesidades y el acabado puede ser tanto laminado como templado. Para su colocación existen unos perfiles que hacen muy sencillo su montaje y desmontaje. Personalizables mediante serigrafía.</p> <p>Panel glass thickness is between 5 and 12mm., depending of customer needs, finished in laminated or tempered glass. Used profiles make for a very easy assembly and disassembly.</p>
puertas doors	<p>En los módulos de la pal 50 podemos colocar puertas de varios tipos: con la hoja de vidrio templado o atamborada de melamina, pueden ser correderas o batientes, dobles o simples... Siempre con herrajes que embellecen la estructura.</p> <p>In pal 50 modules we can install doors of several types: with tempered glass or drummed melamine, sliding or jamb doors, double or single doors... Always with ironworks that embellish the structure.</p>
montaje assembly	<p>La estructura es fácilmente montable y desmontable. Tanto la estructura como los paneles de vidrio y madera, como los herrajes, pueden ser desmontados y reutilizados íntegramente. No es necesaria ningún tipo de obra para su instalación.</p> <p>The structure is easily assembled and detachable. As with the structure, the wood, glass panels, and ironworks can be disassembled and reused. No type of work for its installation is necessary.</p>
manutención maintenance	<p>Las mamparas pal 50 no necesitan mantenimiento alguno. Las superficies son lisas y lavables.</p> <p>Pal 50 partitions do not need maintenance. Surfaces are smooth and washable.</p>

pal 50 mamparas | acabados finishes

melamina melamine

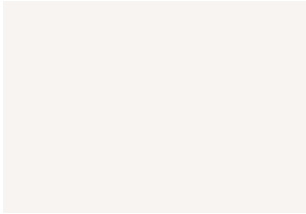

blanco white



aluminio aluminium



antracita anthracite



roble oak



maple maple



cedro cedar



teka natural natural teak



teka ceniza ash teak

madera wood

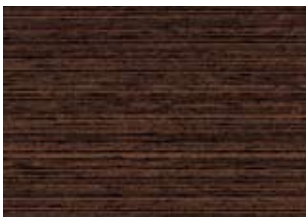

wengué poro abierto
wengue open pore

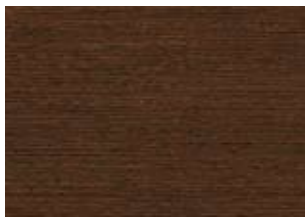

wengué poro cerrado
wengue closed pore



roble blanqueado
white oak



roble natural
natural oak



nogal español
spanish walnut



nogal italiano
italian walnut



teka oscuro dark teak



calidad quality

Dentro del Grupo Ofifran, la excelencia en nuestras operaciones significa
Within Ofifran Group, Operational Excellence means increasing our
aumentar la satisfacción de nuestros clientes, nuestra posición en el
customers' satisfaction, our market position and financial results by
mercado así como los resultados económicos, mediante la garantía de
ensuring continual quality and cost improvement in our processes,
una mejora continua en la calidad y coste de nuestros procesos,
products and services. Deployment of Operational Excellence enables us
productos y servicios. El despliegue de esta excelencia operacional nos
to meet the commitments within our Quality Policy.
permite satisfacer los compromisos de nuestra Política de Calidad.



Ofifran, para la mejora de nuestros productos, se reserva el derecho de
Ofifran, in order to improve our products, reserves the right to delete or
anular o modificar, total o parcialmente, sin previo aviso, cualquiera de los
amend, either totally or partially, without notice,
modelos, colores, formatos, referencias y especificaciones técnicas
any of the designs, colours, shapes, references and
contenidas en este catálogo.
technical specifications included in this catalogue.

Debido a la técnica de impresión, pueden existir diferencias de color entre
Due to the printing technique, there may exist colour differences
el real y el reproducido en este catálogo.
between the real colour and the one reproduced in this catalogue.



pal 50 | elementos elements

2212200101_...

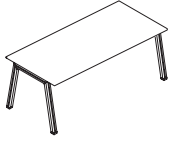

A800 L 1800 H720

2212200102_...



A800 L 1600 H720

2212200103_...

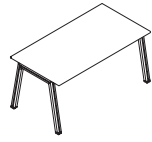

A800 L 1200 H720

2212200104_...



A600 L 1200 H720

2212200105_...



A600 L 800 H720

mesas
tables

2212211301_...



A1500 L 1800 H720

2212211302_...



A1500 L 2400 H720

2212211303_...

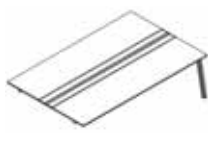

A1500 L 1800 H720

2212211304_...



A1500 L 2400 H720

2212211304_...



A1200 L 1200 H720

22122012012201



L 900 H300

22122012022201



22122012023201



22122012024201



22122012025201



22122012026201



22122105012201



A150 L 800 H100

complementos
complements

2212211501_...



L 1300 H2100

2212211502_...



L 1250 H2100

2212211503_...



L 1900 H2100

2212211504_...



L 1850 H2100

22122115052201
22122115062201



L 1200
L 1800

boxes
boxes

pal 50 | elementos elements

2212201301_

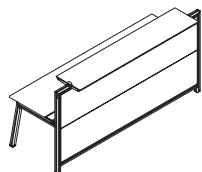

A985 L 1800 H1200

2212201302_

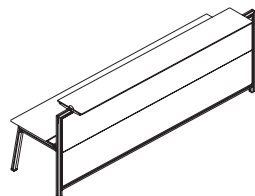

A985 L 2400 H1200

mostradores
counters

2212201302_



A1650 L 1300 H1550

2212201302_



A1650 L 1250 H1550

biombos
screens

MTC123



A570 L420 H550

armarios
storage

MTC124



A570 L420 H550

auxiliares
auxiliary

AM01
A231



A400 L930 H710

AM02
A232



A400 L930 H1350

AM03
A233



A400 L930 H2010

AM11
A241



A400 L470 H710

AM12
A242

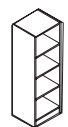

A400 L470 H1350

AM13
A243



A400 L470 H2010

01935_



A20 L920 H670

puertas
doors

01936_



A20 L920 H1310

01937_

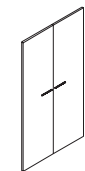

A20 L920 H1980

01935-1



A20 L460 H670

01936-1



A20 L460 H1310

01937-1

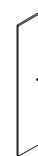

A20 L460 H1980

01961_



A430 L500 H20

01962_



A430 L960 H20

01963_



A430 L1430 H20

01964_



A430 L1890 H20

01965_



A430 L2360 H20

01966_



A430 L2820 H20

tapas
tops

pal 50 mobiliario | opciones de superficie surface options



teka natural natural teak



teka ceniza ash teak

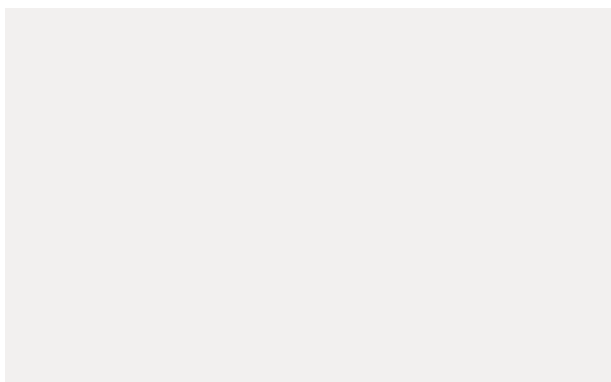



blanco white

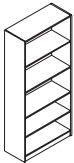

estructura aluminio aluminium structure

pal 50 | datos técnicos technical data

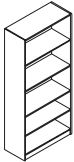
	componente component	material/revestimiento material/covering	construcción construction	acabado finish
mesa table 	estructura frame	perfil de aluminio 50x50mm 50x50mm aluminium beam	ensamblaje mecánico mechanical assembly	anodizado anodized
	tapa top	tablero AG 19mm/bilaminado 19mm particle board/bilaminated	chapado PVC 2mm PVC 2mm veneered	diseños melamina melamine designs
armario metálico metallic cabinet 	puerta ciega wooden door	aluminio-cristal aluminium-glass	perfil embisagrado mechanized	Cromo brillo bright chrome
	marco de puerta de cristal transparente door frame of transparent glass	lámina de acero de 0,8mm 0,8mm steel sheet	soldadura por puntos point welding	pintura epoxi epoxy paint
	cuerpo body	lámina de acero de 0,7mm 0,7mm steel sheet	soldadura por plasma plasma welding	acero steel
	estante shelf	lámina de acero de 0,7mm 0,7mm steel sheet	soldadura por plasma plasma welding	acero steel
cajonera metálica metallic chest of drawers 	cuerpo body	lámina de acero de 0,7mm 0,7mm steel sheet	soldadura por puntos point welding	acero steel
	cajón drawer	lámina de acero de 0,8mm 0,8mm steel sheet	atornillado screwed	acero steel
	frontera front	acero steel	montaje en clip clip assembly	acero steel
armario cabinet 	puerta ciega wooden door	tablero AG 19mm/melamina 19mm particle board/melamine	chapado PVC 1mm PVC 1mm veneered	diseños melamina melamine designs
	marco de puerta de cristal translúcido door frame of transparent glass	aluminio-cristal aluminium-glass	perfil embisagrado mechanized	aluminio aluminium
	cuerpo body	tablero AG 19mm/melamina 19mm particle board/melamine	chapado PVC 1mm PVC 1mm veneered	diseños melamina melamine designs
	estante shelf	tablero AG 25mm/melamina 25 mm particle board/melamine	chapado PVC 1mm PVC 1mm veneered	diseños melamina melamine designs
herraje ironworks	bisagra 107º 107º hinge	acero steel	montaje en clip clip assembly	acero steel
	tirador knob	aluminio aluminium	atornillado screwed	Cromo brillo bright chrome
	cerradura lock	acero inoxidable stainless steel	falleba de pletina embutida inlaid strip espagnolette lock	acero steel
	guía guide	acero inoxidable-rodillos plásticos stainless steel-plastic rollers	atornillado screwed	pintura epoxi epoxy paint

